

# CH Cooper & Hunter

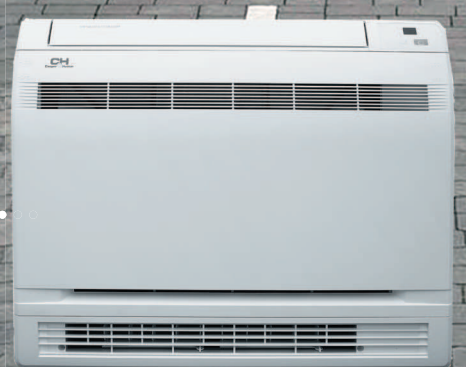

# MULTI-SPLIT SYSTEMS

Nordic Multi Light tai DC - Inverter multi split sistema su laisvai parenkamomis įvairaus tipo vidinėmis dalimis, kurių prie vieno lauko bloko galima pajungti net iki 5 vnt.

Series

# NORDIC MULTI LIGHT

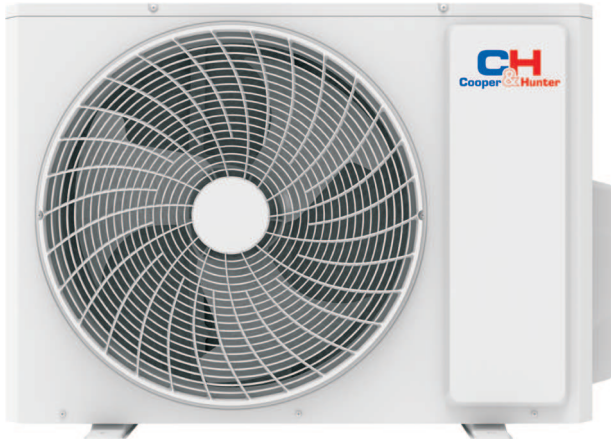

## FUNKCIJOS

INTELLIGENT CONTROL

TECHNOLOGICAL

Energy efficiency



Anti Freeze protection



Auto restart



Self diagnostics



BMS connection



Wired controller connection



R32 Refrigerant



Multi-split



Auto protection



Function 8°C



Technology I-Action



BLUE-FIN



Warm start



Energy Efficiency



Generation 6

## VALDIKLIAI IR PRIEDAI (OPCIJA)



Wired Controller  
XK76



Wired Controller  
CE50-24/E



Wired Controller  
CE52-24/F

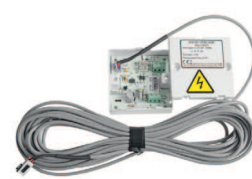

Detection Control Board  
MK010

**LAUKO BLOKAI. GALIA nuo 4,1kW iki 12,1 kW**

MODELIS		CHML-U14RK2-NG	CHML-U18RK2-NG	CHML-U21RK3-NG	CHML-U24RK3-NG	CHML-U28RK4-NG	CHML-U36RK4-NG	CHML-U42RK5-NG
Galimas vidinių bloků skaičius		1-2	1-2	2-3	2-3	2-4	2-4	2-5
Galija	Vėsinimas kW	4.10	5.30	6.10	7.10	8.00	10.60	12.10
	Šildymas kW	4.40	5.65	6.50	8.60	9.50	12.00	13.00
Maitinimas		~220-240V/50Hz/1 Ph						
Oro srautas	m <sup>3</sup> /h	2300	2300	3800	3800	3800	5800	5800
Garso slėgio lygis	dB (A)	52	54	58	58	58	60	60
Svoris (net/gross)	kg	30/32.5	32/34.5	47.5/52	47.5/52	51/55.5	72/79	73/80
Šaltnešio tipas		R32						
Šaltnešio kiekis	kg	0.75	0.90	1.60	1.70	1.80	2.40	2.4
Pap. šaltnešio kiekis	g/m	20	20	20	20	20	20	20
Standartinis užpild. ilgis	m	10	10	30	30	40	40	50
Vamzdyno matmenys skystis/dujos	mm/inch	2x 6.35/1/4"-9.52/3/8"	2x 6.35/1/4"-9.52/3/8"	3x 6.35/1/4"-9.52/3/8"	3x 6.35/1/4"-9.52/3/8"	4x 6.35/1/4"-9.52/3/8"	4x 6.35/1/4"-9.52/3/8"	5x 6.35/1/4"-9.52/3/8"
Darbinės lauko temperatūros ribos	Vėsinimas °C	-15 ... +43						
	Šildymas °C	-22 ... +20						
Maksimalus vamzdyno ilgis (suminis/vienos atšakos)	m	40/20	40/20	60/20	60/20	70/20	80/25	100/25
Maksimalus vamzdyno aukščio perkrytis	m	15	15	15	15	15	25	25

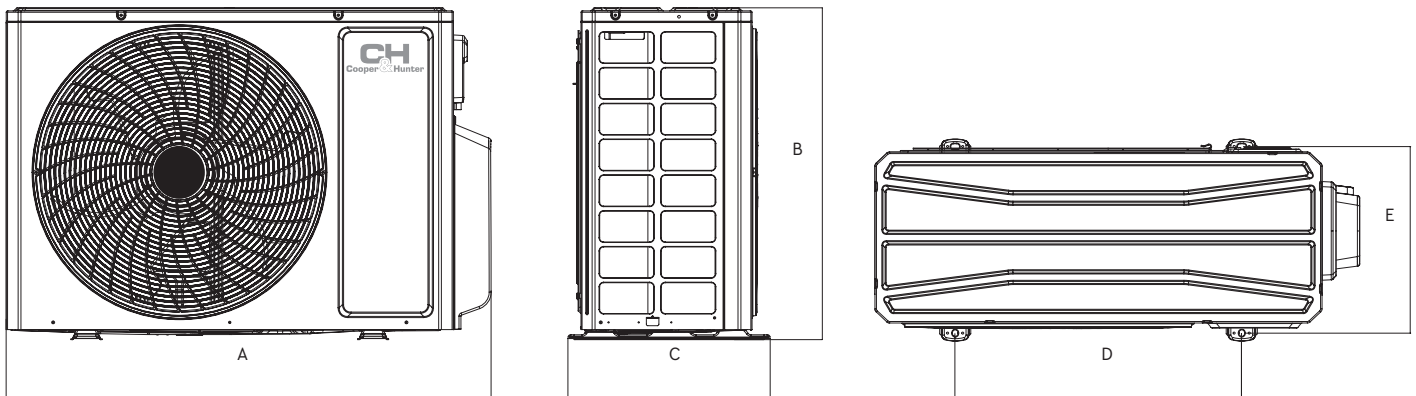

MODELIS	A (mm)	B (mm)	C (mm)	D (mm)	E (mm)
CHML-U14RK2-NG	822	550	352	512	332
CHML-U18RK2-NG	822	550	352	512	332
CHML-U21RK3-NG	964	660	402	570	371
CHML-U24RK3-NG	964	660	402	570	371
CHML-U284RK4-NG	964	660	402	570	371
CHML-U36RK4-NG	1020	826	427	635	396
CHML-U42RK5-NG	1020	826	427	635	396

# Series SUPREME CONTINENTAL



## TECHNINIAI DUOMENYS

MODELIS		CH-S09FTXAL-* (I)	CH-S12FTXAL-* (I)	CH-S18FTXAL-* (I)	CH-S24FTXAL-* (I)	
Galia	Vėsinimas	kW	2.70	3.50	5.30	7.00
	Šildymas	kW	2.93	3.81	5.57	7.20
Maitinimas		~220-240V/50Hz/1 Ph				
Skysčio vamzdžio skersmuo	mm/inch	6.35/1/4"	6.35/1/4"	6.35/1/4"	6.35/1/4"	
Dujų vamzdžio skersmuo	mm/inch	9.52/3/8"	9.52/3/8"	12.7/1/2"	15.88/5/8"	
Oro srautas	m <sup>3</sup> /h	390/420/450/490/540/590/660	390/420/450/490/540/590/680	306/520/580/610/750/800/850	750/850/900/950/1000/1100/1250	
Garso slėgio lygis	dB (A)	18/22/26/35/37/39/41	19/24/28/35/37/39/43	30/33/36/41/43/45/49	32/35/38/42/44/47/49	
Kondensato kiekis	l/h	0.8	1.4	1.8	2.4	
Svoris	kg	10.5	11	13.5	16.5	

\* - galimos spalvos: balta(WP), pilka(SC), aukso(GD), juoda(FB)

## FUNKCIJOS

HEALTH				COMFORT MANAGEMENT									
Mode SLEEP	Technology CH 7-SKY	ECO-FRESH	CH SMART-ION Filter	Locking the remote control	Timer	LED display	Turbo mode	Multi speed fan	SWING mode	Dehumidification mode	Self-clean	Wi-Fi	I FEEL

## MATMENYS

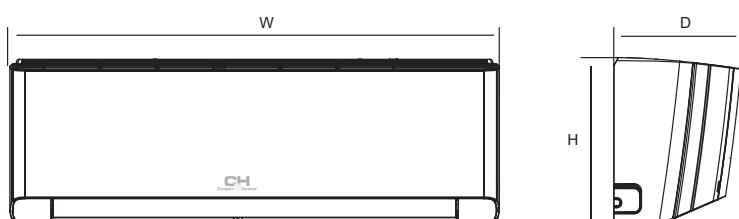

MODELIS	W (mm)	H (mm)	D (mm)
CH-S09FTXAL-GD/SC/BL/WP/FB (I)	865	290	210
CH-S12FTXAL-GD/SC/BL/WP/FB (I)	865	290	210
CH-S18FTXAL-GD/SC/BL/WP/FB (I)	996	301	225
CH-S24FTXAL-GD/SC/BL/WP/FB (I)	1101	327	249

Series **VITAL INVERTER**

## TECHNINIAI DUOMENYS

MODELIS			CH-S07FTXF2-NG (I)	CH-S09FTXF2-NG (I)	CH-S12FTXF2-NG (I)	CH-S18FTXF2-NG (I)	CH-S24FTXF2-NG (I)
Galia	Cooling	kW	2.35 (0.37-2.53)	2.70 (0.50-3.35)	3.20 (0.60-3.60)	4.60 (0.65-5.20)	6.20 (1.80-6.90)
	Heating	kW	2.50 (0.51-2.60)	2.80 (0.50-3.30)	3.40 (0.60-3.80)	5.20 (0.70-5.40)	6.50 (1.30-7.03)
Maitinimas			~220-240V/50Hz/1 Ph				
Skysčio vamzdžio skersmuo	mm/inch		6.35/1/4"	6.35/1/4"	6.35/1/4"	6.35/1/4"	6.35/1/4"
Dujų vamzdžio skersmuo	mm/inch		9.52/3/8"	9.52/3/8"	9.52/3/8"	9.52/3/8"	12.7/1/2"
Oro srautas	m <sup>3</sup> /h		300/390/420/500	280/310/340/400/480/520/550	280/320/350/400/480/520/590	600/700/800/850	400/600/800/900
Garso slėgio lygis	dB (A)		27/33/38/40	21/26/29/33/35/37/40	24/26/30/33/35/37/41	31/38/42/44	30/37/45/48
Kondensato kiekis	l/h		0.6	0.8	1.4	1.8	1.8
Svoris	kg		8.2	8.5	8.0	13.5	13

## FUNKCIJOS

## HEALTH

## COMFORT MANAGEMENT



Mode SLEEP



Technology CH 7-SKY



ECO-FRESH



CH SMART-ION Filter



Double Self-clean



Locking the remote control



Timer



LED display



Turbo mode



Multi speed fan



Dehumidification mode



Self-clean



Wi-Fi



I FEEL

## MATMENYS

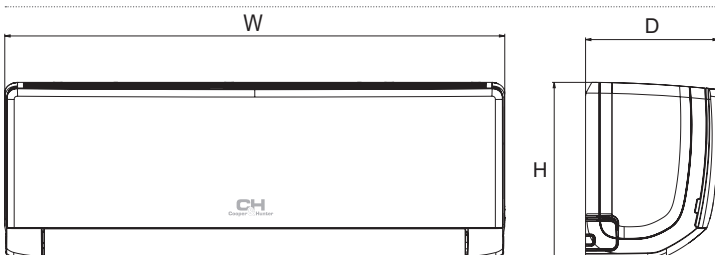

MODEL	W (mm)	H (mm)	D (mm)
CH-S07FTXF2-NG (I)	713	270	195
CH-S09FTXF2-NG (I)	773	250	185
CH-S12FTXF2-NG (I)	773	250	185
CH-S18FTXF2-NG (I)	970	300	225
CH-S24FTXK2-NG (I)	970	300	225

# CONSOLE TYPE



## TECHNINIAI DUOMENYS

MODEL			CHML-IK09FVX-N6(I)	CHML-IK12FVX-N6(I)	CHML-IK18FVX-N6(I)
Galia	Vėsinimas	kW	2.70 (0.70-3.40)	3.52 (0.80-4.40)	5.20 (1.26-6.60)
	Šildymas	kW	2.90 (0.60-3.50)	3.80 (1.10-4.40)	5.33 (1.12-6.68)
Maitinimas			~220-240V/50Hz/1 Ph		
Skysčio linijos skersmuo		mm/inch	6.35/1/4"	6.35/1/4"	6.35/1/4"
Dujų linijos skersmuo		mm/inch	9.52/3/8"	9.52/3/8"	12.7/1/2"
Oro srautas		m <sup>3</sup> /h	250/280/330/370/410/430/500	280/360/400/440/480/520/600	320/410/460/520/580/650/700
Garso slėgio lygis		dB (A)	22/25/28/30/32/36/38	24/29/33/36/38/40/44	32/37/40/42/45/47/49
Kondensato kiekis		l/h	0.8	1.2	1.8
Weight		kg	15.5	16	16

## FUNKCIJOS

### HEALTH



Mode SLEEP



ECO-FRESH



CH SMART-ION Filter



Locking the remote control



Timer



LED display



Turbo mode



Multi speed fan



Dehumidification mode



Self-clean



Wi-Fi



I FEEL

### COMFORT MANAGEMENT

## MATMENYS

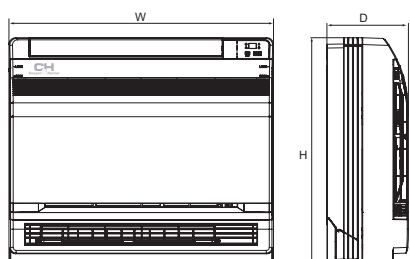

MODELIS	W (mm)	H (mm)	D (mm)
CHML-IK09FVX-N6(I)	700	600	215
CHML-IK12FVX-N6(I)	700	600	215
CHML-IK18FVX-N6(I)	700	600	215

# CASSETTE TYPE



CE RoHS



## TECHNINIAI DUOMENYS

MODELIS			CHML-IC12RK2	CHML-IC18RK2	CHML-IC24RK2
Galia	Cooling	kW	3.50	5.00	7.00
	Heating	kW	4.0	5.50	8.0
Maitinimas	~220-240V/50Hz/1 Ph				
Skysčio vamzdžio skersmuo		mm/inch	6.35/1/4"	6.35/1/4"	9.52/3/8"
Dujų vamzdžio skersmuo		mm/inch	9.52/3/8"	12.7/1/2"	15.88/5/8"
Oro srautas		m <sup>3</sup> /h	560/540/490/450/420/380/350	650/540/490/450/420/380/350	1100/1050/950/910/870//830/800
Garso slėgio lygis		dB (A)	57/55/52/50/48/46/44	59/55/52/50/48/46/44	32/61/60/59/58/57/55
Svoris (kasetė/panelė)		kg	17.0/2.5	17.0/2.5	29.0/5.5

## FUNKCIJOS

HEALTH	COMFORT MANAGEMENT	INTELLIGENT CONTROL	TECHNOLOGICAL
Mode SLEEP ECO-FRESH Timer LED display Turbo mode	Multi speed fan Wi-Fi Dehumidification mode Anti Freeze protection	Auto restart Self diagnostics Wired controller connection	Build-in Drine Pump Coating BLUE-FIN Silent mode

## MATMENYS

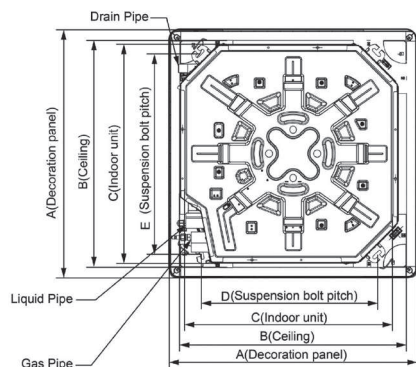

MODEL	A (mm)	B (mm)	C (mm)	D (mm)	E (mm)	F (mm)	G (mm)	H (mm)	I (mm)
CHML-IC12RK2	620	580	570	505	550	265	140	530	530
CHML-IC18R2K	620	580	570	505	550	265	140	530	530
CHML-IC24RK2	950	870	840	680	780	240	135	-	-

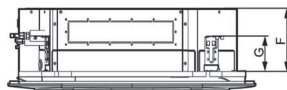



# DUCT TYPE

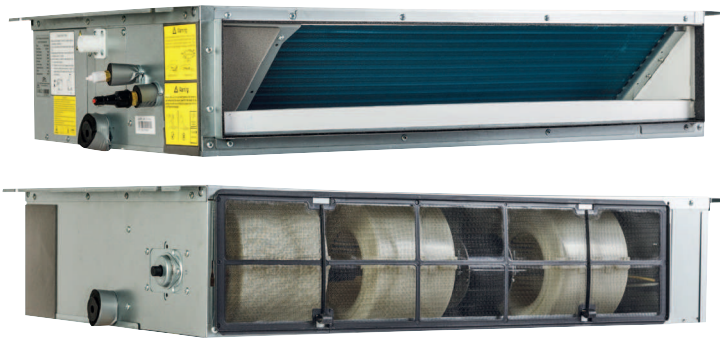

CE RoHS



## TECHNINIAI DUOMENYS

MODELIS			CHML- ID09RK2	CHML- ID12RK2	CHML- ID18RK2	CHML- ID24RK2
Galia	Vėsinimas	kW	2.65	3.5	5.0	7.0
	Šildymas	kW	2.80	4.00	5.5	8.0
Maitinimas			~220-240V/50Hz/1 Ph			
Skysčio vamzdžio skersmuo		mm/inch	6.35/1/4"	6.35/1/4"	6.35/1/4"	9.52/3/8"
Dujų vamzdžio skersmuo		mm/inch	9.52/3/8"	9.52/3/8"	12.7/1/2"	15.88/5/8"
Oro srautas		m <sup>3</sup> /h	700/670/640/610/580/550/520	650/560/520/480/450/410/380	880/840/810/790/770/750/730	1500/1200/1200/1000/1000/900/900
Garso slėgio lygis		dB (A)	41/39/38/37/36/35/34	39/37/36/35/34/33/32	41/39/39/38/38/37/34	45/40/40/38/38/36/36
Svoris		kg	18.5	19	25	31

## FUNKCIJOS

HEALTH			COMFORT MANAGEMENT				INTELLIGENT CONTROL				TECHNOLOGICAL			
Mode SLEEP	ECO-FRESH	Fresh Air mode	Timer	Turbo mode	Multi speed fan	Wi-Fi	Dehumidification mode	Anti Freeze protection	Auto restart	Self diagnostics	Wired controller connection	Build-in Drine Pump	Coating BLUE-FIN	Silent mode

## DIMENSIONS

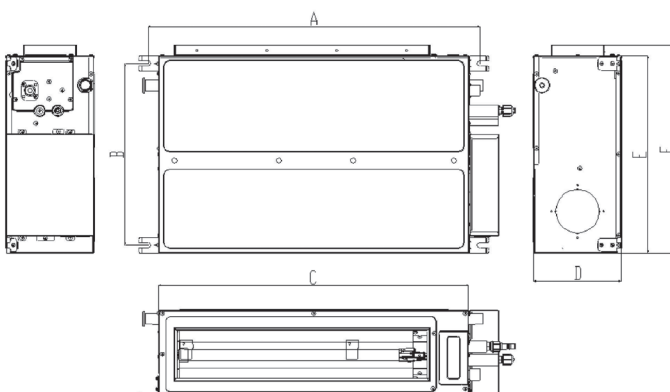

MODEL	A (mm)	B (mm)	C (mm)	D (mm)	E (mm)	F (mm)
CHML-ID09RK2	760	415	710	200	450	474
CHML-ID09RK2	760	415	710	200	450	474
CHML-ID18RK2	1060	415	1010	200	450	474
CHML-ID24RK2	942	530	900	260	655	685

## LAUKO DALIES IR VIDINIŲ BLOKŲ DERINIMO VARIANTAI

### CHML-U14RK2-NG | 8 variantai



Viena dalis	Dvi dalys	
7	7+7	7+9
9	7+12	9+9
12	9+12	

### CHML-U18RK2-NG | 10 variantų



Viena dalis	Dvi dalys		
7	7+7	9+9	12+12
9	7+9	9+12	
12	7+12		

### CHML-U21RK3-NG | 18 variantų

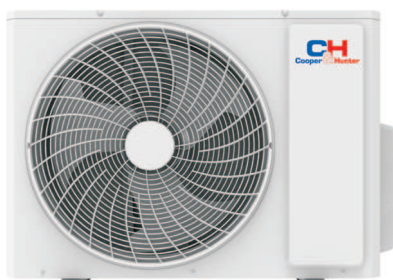

Dvi dalys		Trys dalys	
7+7	7+9	7+7+7	7+7+9
7+12	7+18	7+7+12	7+9+9
9+9	9+12	7+9+12	9+9+12
9+18	12+12	9+9+9	
12+18			

### CHML-U24RK3-NG | 23 variantai

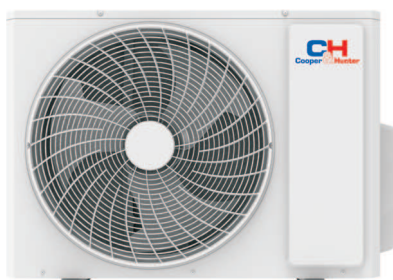

Dvi dalys		Trys dalys		
7+7	7+9	7+7+7	7+7+9	7+7+12
7+12	7+18	7+7+18	7+9+9	7+9+12
9+9	9+12	7+9+18	7+12+12	9+9+9
9+18	12+12	9+9+12	9+9+18	9+12+12
12+18	18+18	12+12+12		

### CHML-U28RK4-NG | 40 variantų

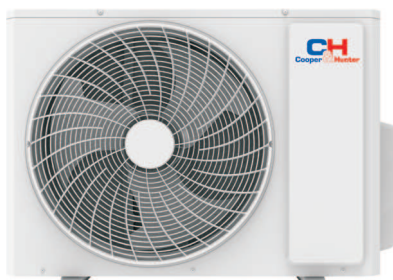

Dvi dalys		Trys dalys			Keturiios dalys		
7+7	7+9	7+7+7	7+7+9	7+7+12	7+7+7+7	7+7+7+9	7+7+7+12
7+12	7+18	7+7+18	7+9+9	7+9+12	7+7+7+18	7+7+9+9	7+7+9+12
9+9	9+12	7+9+18	7+12+12	7+12+18	7+7+9+18	7+7+12+12	7+9+9+9
9+18	12+12	9+9+9	9+9+12	9+9+18	7+9+9+12	7+9+12+12	9+9+9+9
12+18	18+18	9+12+12	9+12+18	12+12+12	9+9+9+12	9+9+12+12	
		12+12+18					

## CHML-U36RK4-NG | 96 variantai



Dvi dalys		Trys dalys			Keturi dalys		
7+12	7+18	7+7+7	7+7+9	7+7+12	7+7+7+7	7+7+7+9	7+7+7+12
7+21	7+24	7+7+18	7+7+21	7+7+24	7+7+7+18	7+7+7+21	7+7+7+24
9+9	9+12	7+9+9	7+9+12	7+9+18	7+7+9+9	7+7+9+12	7+7+9+18
9+18	9+21	7+9+21	7+9+24	7+12+12	7+7+9+21	7+7+9+24	7+7+12+12
9+24	12+12	7+12+18	7+12+21	7+12+24	7+7+12+18	7+7+12+21	7+7+18+18
12+18	12+21	7+18+18	7+18+21	7+18+24	7+7+12+24	7+9+9+12	7+9+9+18
12+24	18+18	7+21+21	9+9+9	9+9+12	7+9+9+9	7+9+9+24	7+9+12+12
18+21	18+24	7+21+24	9+9+21	9+9+24	7+9+9+21	7+9+12+21	7+9+18+18
21+21	21+24	9+9+18	9+12+18	9+12+21	7+9+12+18	7+12+12+18	9+9+9+9
24+24		9+12+12	9+18+18	9+18+21	7+9+12+24	9+9+9+18	9+9+9+21
		9+12+24	9+21+21	12+12+12	7+12+12+12	9+9+12+12	9+9+12+18
		9+18+24	12+12+21	12+12+24	7+12+12+21	9+9+18+18	9+12+12+12
		9+21+24	12+18+21	18+18+18	9+9+9+12	9+9+12+24	
		12+12+18	12+21+21		9+9+9+24	9+12+12+21	
		12+18+18			9+9+12+21	12+12+12+12	
		12+18+24			9+12+12+18		
					12+12+12+18		

## CHML-U42RK5-NG | 199 variantai

Dvi dalys		Trys dalys			Keturi dalys				Penkios dalys			
7+18	7+21	7+7+7	7+7+9	7+7+12	7+7+7+7	7+7+7+9	7+7+7+12	7+7+7+18	7+7+7+7+7	7+7+7+7+9	7+7+7+7+12	7+7+7+7+18
7+24	9+12	7+7+18	7+7+21	7+7+24	7+7+7+21	7+7+7+24	7+7+9+9	7+7+9+12	7+7+7+7+21	7+7+7+7+24	7+7+7+9+9	7+7+7+9+12
9+18	9+21	7+9+9	7+9+12	7+9+18	7+7+9+18	7+7+9+21	7+7+9+24	7+7+12+12	7+7+7+9+18	7+7+7+9+21	7+7+7+9+24	7+7+7+12+12
9+24	12+12	7+9+21	7+9+24	7+12+12	7+7+12+18	7+7+12+21	7+7+12+24	7+7+18+18	7+7+7+12+18	7+7+7+12+21	7+7+7+12+24	7+7+7+18+18
12+18	12+21	7+12+18	7+12+21	7+12+24	7+7+18+21	7+7+18+24	7+7+21+21	7+7+21+24	7+7+7+18+21	7+7+9+9+9	7+7+9+9+12	7+7+9+9+18
12+24	18+18	7+18+18	7+18+21	7+18+24	7+9+9+9	7+9+9+12	7+9+9+18	7+9+9+21	7+7+9+9+21	7+7+9+9+24	7+7+9+12+12	7+7+9+12+18
18+21	18+24	7+21+21	7+21+24	7+24+24	7+9+9+24	7+9+12+12	7+9+12+18	7+9+12+21	7+7+9+12+21	7+7+9+12+24	7+7+9+18+18	7+7+12+12+12
21+21	21+24	9+9+9	9+9+12	9+9+18	7+9+12+24	7+9+18+18	7+9+18+21	7+9+18+24	7+7+12+12+18	7+7+12+12+21	7+7+12+18+18	7+9+9+9+9
24+24		9+9+21	9+9+24	9+12+12	7+9+21+21	7+9+21+24	7+12+12+12	7+12+12+18	7+9+9+9+12	7+9+9+9+18	7+9+9+9+21	7+9+9+9+24
		9+12+18	9+12+21	9+12+24	7+12+12+21	7+12+12+24	7+12+18+18	7+12+18+21	7+9+9+12+12	7+9+9+12+18	7+9+9+12+21	7+9+9+12+24
		9+18+18	9+18+21	9+18+24	7+12+18+24	7+12+21+21	7+18+18+18	9+9+9+9	7+9+9+18+18	7+9+12+12+12	7+9+12+12+18	7+9+12+12+21
		9+21+21	9+21+24	9+24+24	9+9+9+12	9+9+9+18	9+9+9+21	9+9+9+24	7+12+12+12+12	7+12+12+12+18	9+9+9+9+9	9+9+9+9+12
		12+12+12	12+12+18	12+12+21	9+9+12+12	9+9+12+18	9+9+12+21	9+9+12+24	9+9+9+9+18	9+9+9+9+21	9+9+9+9+24	9+9+9+12+12
		12+12+24	12+18+18	12+18+21	9+9+18+18	9+9+18+21	9+9+18+24	9+9+21+21	9+9+9+12+18	9+9+9+12+21	9+9+9+18+18	9+9+12+12+12
		12+18+24	12+21+21	12+21+24	9+9+21+24	9+12+12+18	9+12+12+21	9+12+12+24	9+9+12+12+18	9+9+12+12+21	9+12+12+12+12	9+12+12+12+18
		12+24+24	18+18+18	18+18+21	9+12+12+12	9+12+18+21	9+12+21+21	9+18+18+18	12+12+12+12+12	9+9+9+12+24		
		18+18+24	18+21+21	21+21+21	9+12+18+18	12+12+12+18	12+12+12+21	12+12+12+24				
		18+21+24			9+12+18+24	12+12+18+21						
					12+12+12+12							
					12+12+18+18							